

Panasonic

AUTOMATIC TELEPHONE
ANSWERING SYSTEM

EASA-PHONE®

Model No. **KX-T5000**

Operating Instructions



Please read before use.

AUTO-LOGIC™

La referencia rápida en español puede ser encontrada en la páginas 38-43.

Please read **IMPORTANT SAFETY INSTRUCTIONS** on pages 34–35 before use. Read and understand all instructions.

Introduction (Features)

Thank you for purchasing the Panasonic KX-T5000.

The KX-T5000 is an automatic telephone answering system with dual micro cassette tapes. You can use the following convenient features.

New message playback (p. 17)

Listening to only the messages you have not played back before

Call counter (p. 16)

Recording your own message (p. 20)

Tone remote operation (p. 23–28)

Listening to all messages or new messages from a remote location with touch tone phone (p. 24)

Accessories (See page 33 for accessory order information.)

AC Adaptor (KX-A11)
(p. 7)



one

Telephone Line Cord
(p. 7)

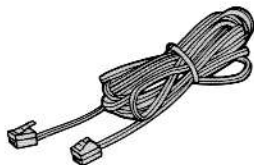

one

Micro Cassette Tapes (p. 6, 32)
Greeting Message Tape (MC-10)

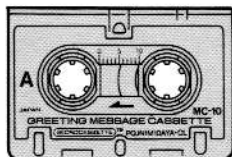

one

Incoming Message Tape (MC-30)

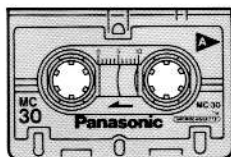

one

Contents

Location of controls	4
Setting up the unit	6
Inserting the cassette tapes	6
Connection	7
Setting selectors	8
Recording a greeting message	10
Checking the greeting message	12
Adjusting the VOLUME control	12
Setting the CPC (Calling Party Control) function	13
Automatic answering operation	14
Setting the unit to answer the call	15
Resetting the incoming message	15
Listening to the recorded messages	16
Listening to new messages only	17
Listening to all the recorded messages	17
Saving some old messages	19
Recording your own message	20
Recording a telephone conversation	21
Monitoring incoming calls	22
Remote operation from a touch tone phone	23
Setting the remote code number	23
Basic remote operation	24
Advanced remote operation	26
Troubleshooting guide	31
Maintenance	32
Accessory order information	33
Important safety instructions	34
FCC and other information	36
Referencia rápida	38

Location of controls

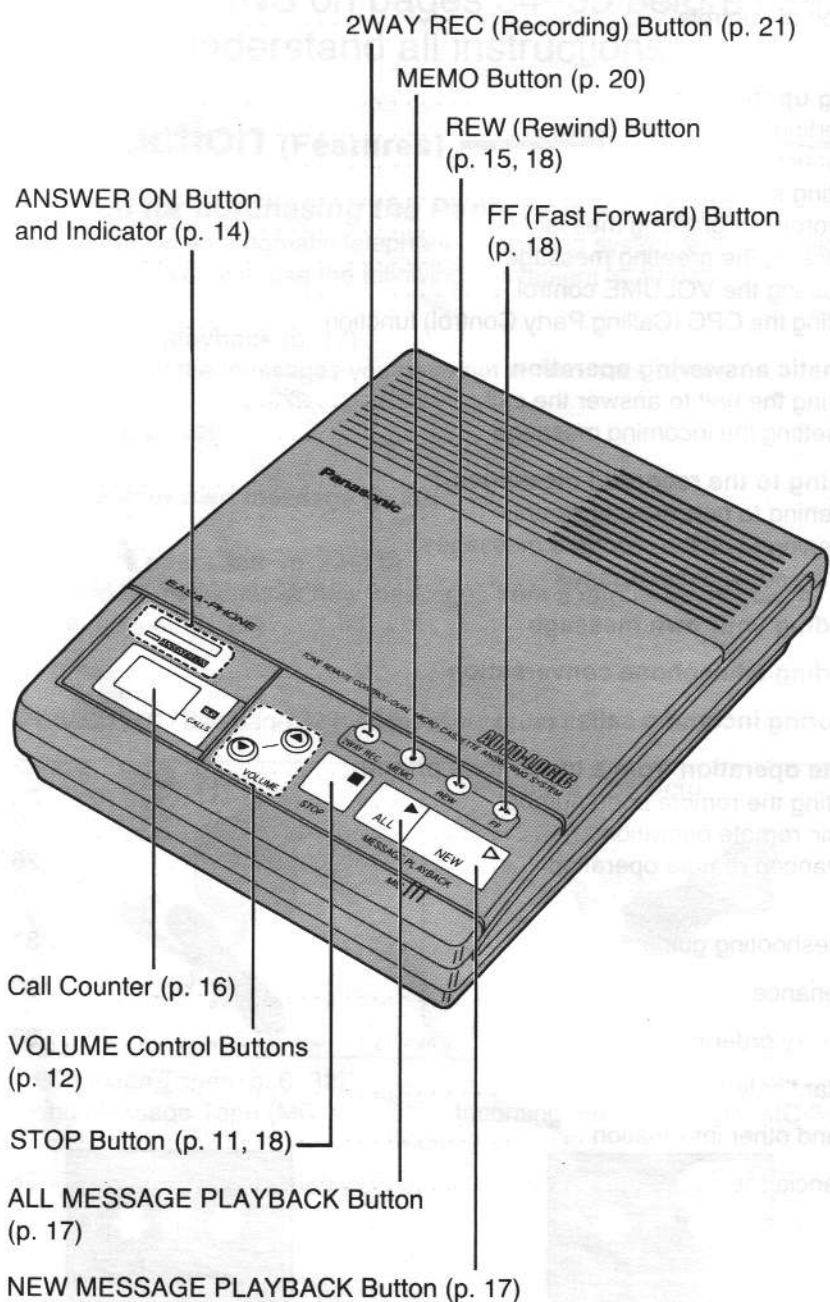

REMOTE CODE Button (p. 23)
GREETING CHECK Button (p. 12)
GREETING RECORD Button (p. 11)

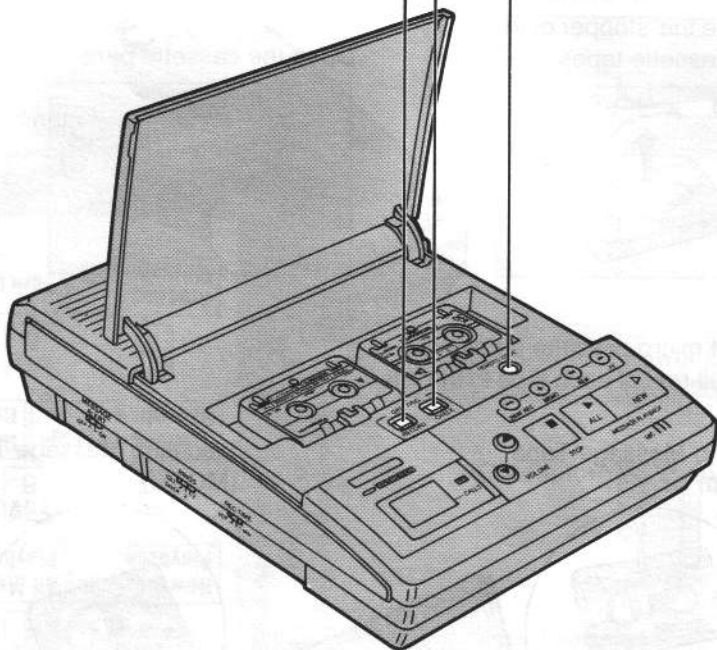

MESSAGE ALERT
Selector (p. 9)

RINGS (Ring times)
Selector (p. 9)

REC (Recording) TIME Selector (p. 9)

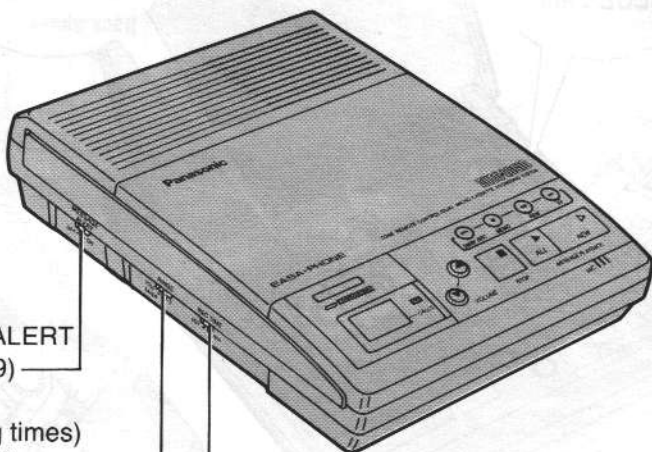

Setting up the unit

Inserting the cassette tapes

Remove the stopper of the micro cassette tapes.

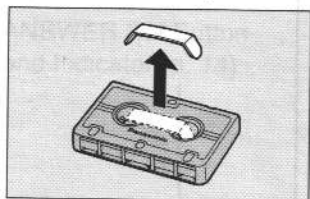

Open the cassette panel.

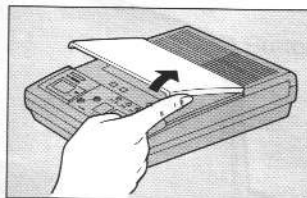

Insert micro cassette tapes with the full reel of each tape to the left.

Greeting Message Tape
(MC-10)

Incoming Message Tape
(MC-30)

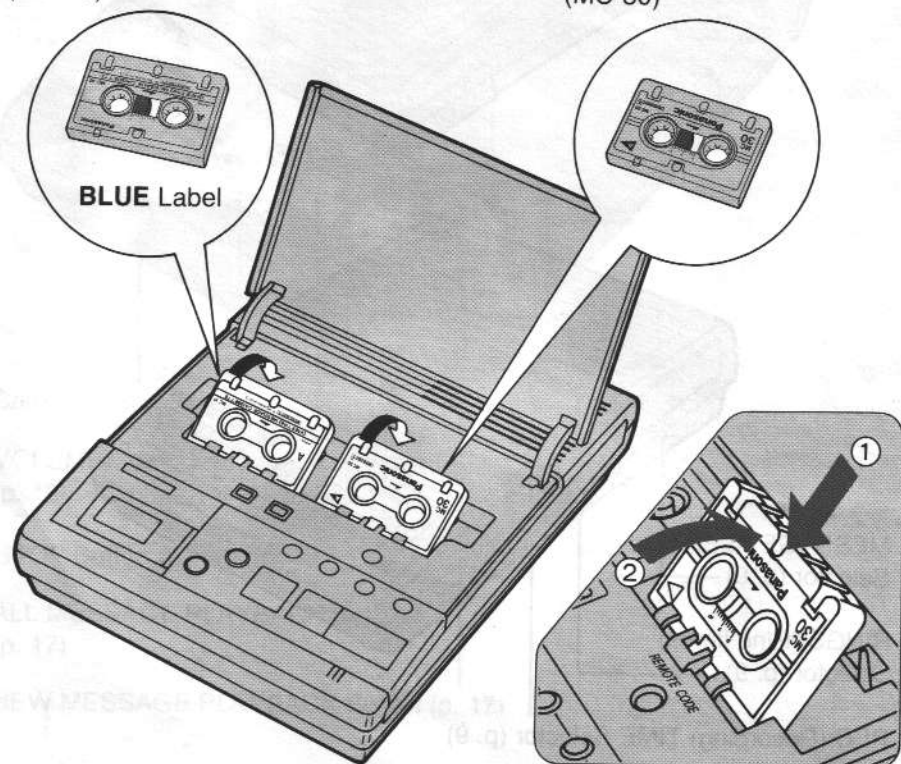

Connection

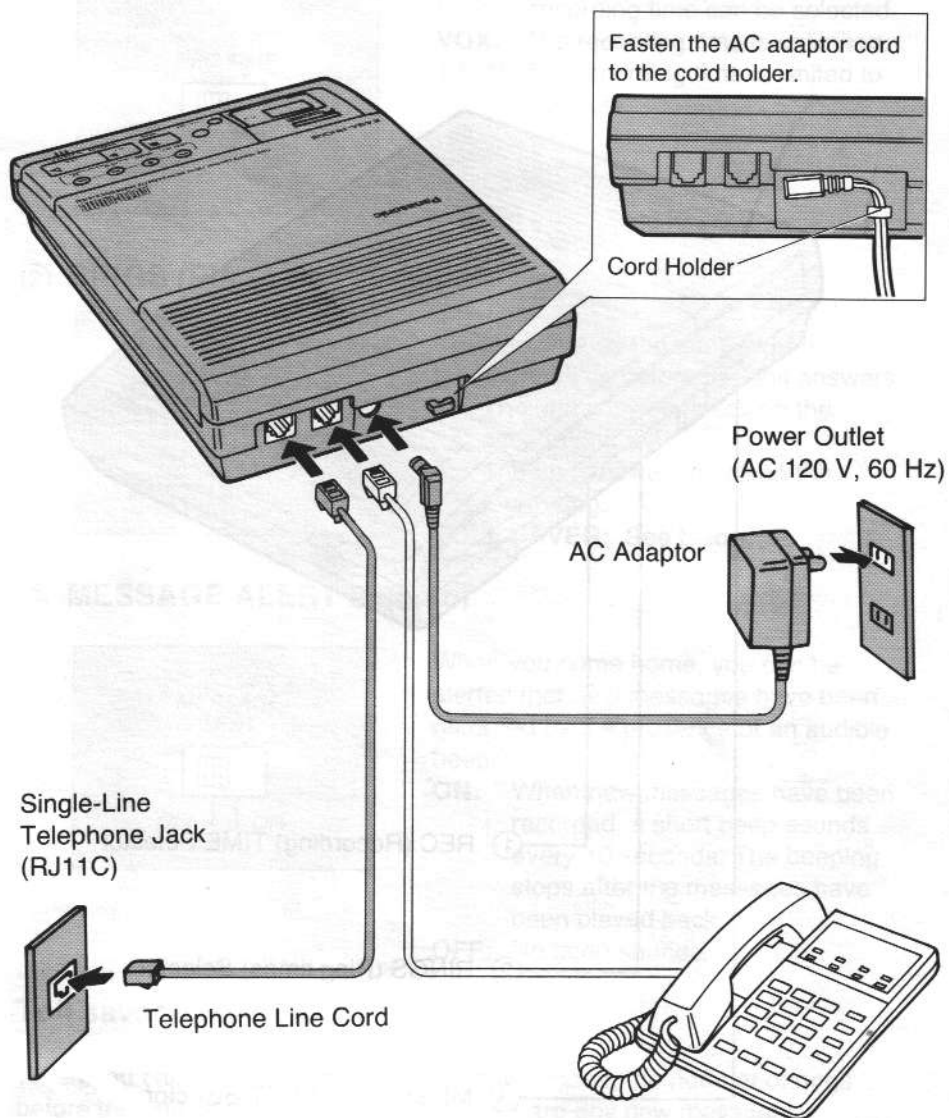

Note:

- USE ONLY Panasonic AC ADAPTOR KX-A11.
- AC adaptor must remain connected at all times.

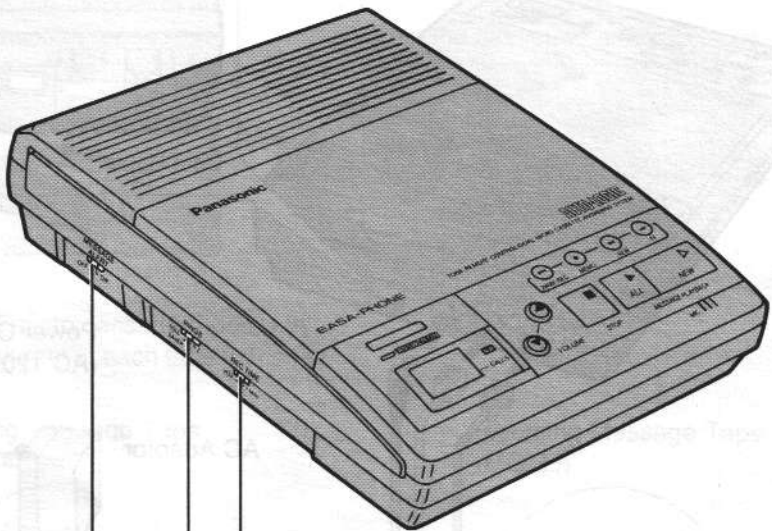

① REC (Recording) TIME Selector

② RINGS (Ring times) Selector

③ MESSAGE ALERT Selector

① REC (Recording) TIME Selector

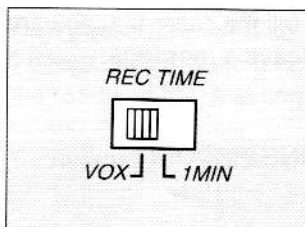

Caller's recording time can be selected.
VOX: The recording time is unlimited.
1 MIN: The recording time is limited to 1 minute.

② RINGS (Ring times) Selector

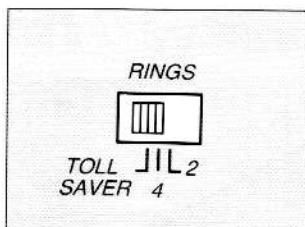

You can choose the number of the telephone rings before the unit answers.
2: The unit answers a call on the second ring.
4: The unit answers a call on the fourth ring.
TOLL SAVER: See below.

③ MESSAGE ALERT Selector

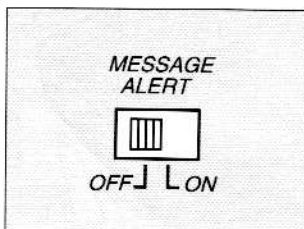

When you come home, you can be alerted that new messages have been recorded by the presence of an audible beep.
ON: When new messages have been recorded, a short beep sounds every 10 seconds. The beeping stops after the messages have been played back.
OFF: No beep sounds.

Toll saver

When you call the unit from a touch tone telephone, the number of rings before the unit answers informs you if there are any new messages.

- If the unit answers on the 2nd ring: There is at least one new message.
- If the unit answers on the 4th ring: There are no new messages.

Hang up immediately when you hear the 3rd ring. Because the 3rd ring indicates there are no new messages. This saves you the toll charge for the call.

Recording a greeting message

The greeting message is an announcement to tell the caller that you are unable to answer the call and asks him/her to leave a message.

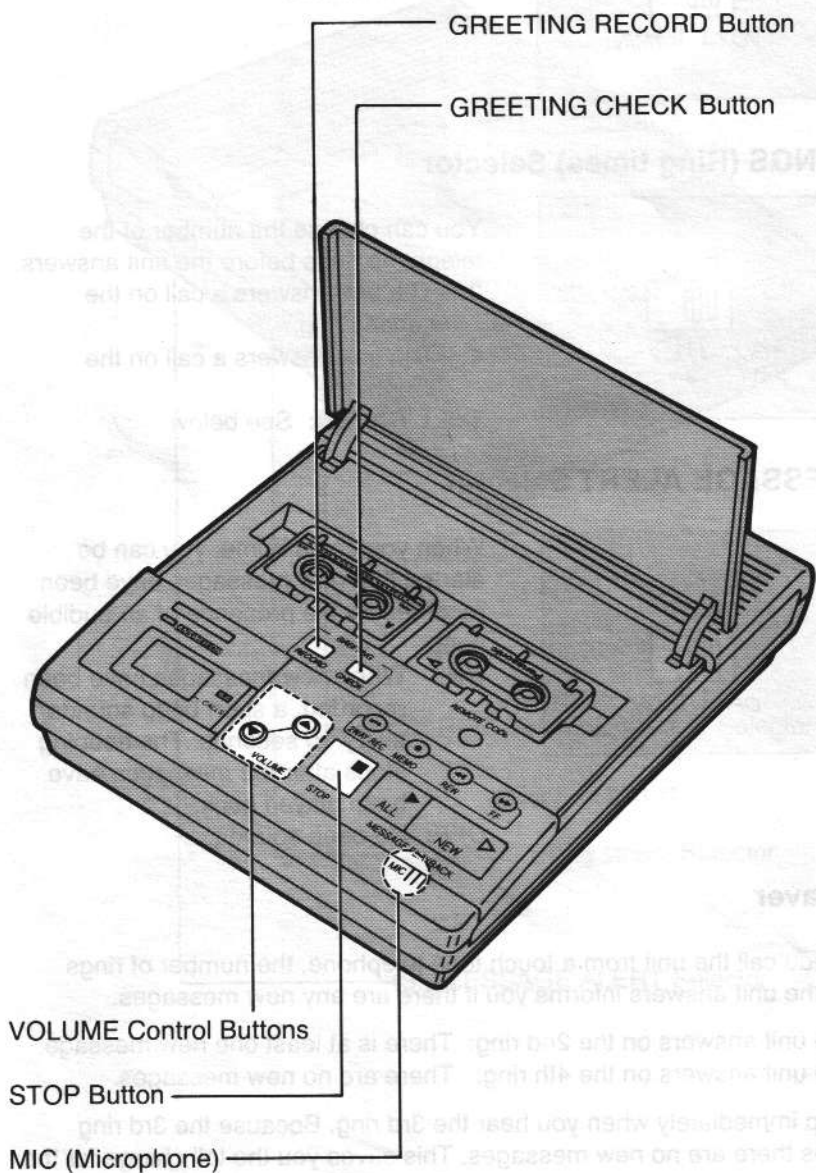

Caution:

- You can record your greeting message up to the tape end.
- Do not pause for over 5 seconds while recording.
If 6 beeps sound while recording, start again from step 1 after the unit stops resetting the greeting message tape.

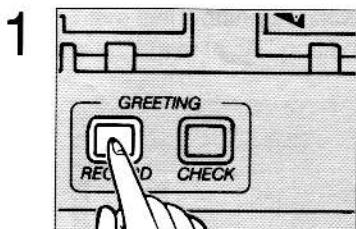

Press the GREETING RECORD button, then release it.

- A long beep sounds.

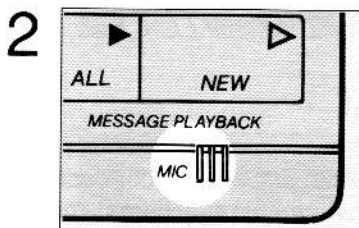

Immediately after the long beep, speak clearly and loudly, 20 cm (8") away from the microphone.

- The call counter shows the elapsed recording time.

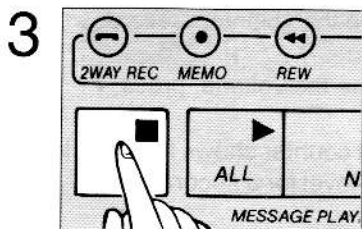

When you finish recording, press the STOP button.

Sample greeting messages

When the REC TIME selector is set to the "VOX" position:

"Hello, this is (your name and/or number). Sorry, I cannot take your call. Please leave your message after a long beep. Thank you."

When the REC TIME selector is set to the "1 MIN" position:

"Hello, this is (your name and/or number). Sorry, I cannot take your call. Please leave your message after a long beep. Your recording time is up to 1 minute. Thank you."

Checking the greeting message

You can play back and check your recorded greeting message.

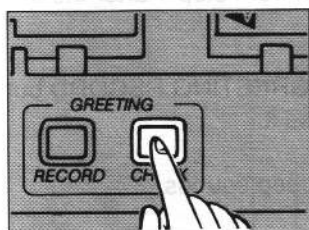

Press the GREETING CHECK button to play back the greeting message.

Adjusting the VOLUME control

There are 8 levels of speaker volume, and you can adjust it to your desired level using the VOLUME control buttons, 0 (minimum) through 8 (maximum).

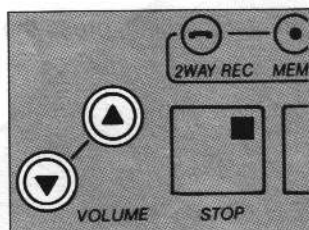

To increase the volume, press ▲.

To decrease the volume, press ▼.

— The call counter shows the selected volume level for 3 seconds.

Setting the CPC (Calling Party Control) function

With this function, the unit senses the hung-up click and stops recording, thereby maximizing the time available on your cassette tape.

The CPC function of this unit is preset to "A" position.

If you have call waiting service, set to "b" position.

Otherwise, leave in "A" position.

1

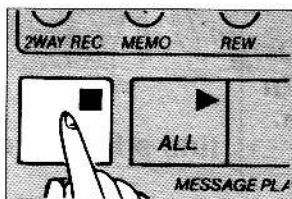

Press the STOP button until the call counter shows "P".

2

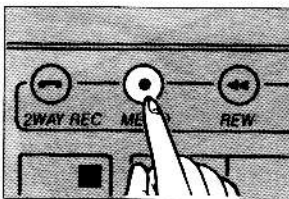

Within 5 seconds after pressing the STOP button, press the MEMO button to set "A" or "b".

— The call counter shows the current setting.

A or **b**

- Each time you press the MEMO button, "A" or "b" will change alternately.
- Wait for 5 seconds after setting. Then the setting indicated on the call counter is stored, and it changes into the number of messages.
- To check the CPC function, repeat from step 1 to 2.

Automatic answering operation

When a call reaches, the unit plays back your greeting message, and records the caller's message. After the call is completed, it will be ready for the next call automatically.

ANSWER ON Button and Indicator

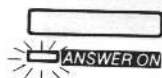

The answering system works when the **ANSWER ON** indicator light is on.

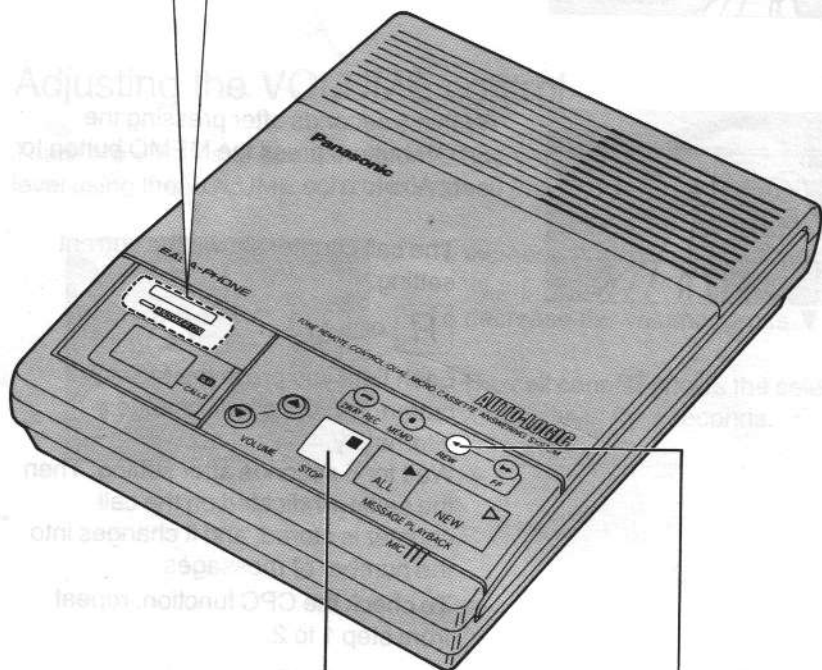

STOP Button

REW Button

Note:

— After a power failure, the call counter shows “—”. In this case, please check your CPC function (See page 13.) and remote code number. (See page 23.)

Setting the unit to answer the call

To answer a call and record the callers message, set the unit as follows.



Press the ANSWER ON button to turn on the answering system.

- The ANSWER ON indicator light is on, and the unit is now ready to answer the call.
- The call counter shows "0".

To turn off the unit

If you do not want the unit to answer the call, press the ANSWER ON button, and confirm the ANSWER ON indicator light goes out.

Resetting the incoming message tape

To record new messages from the beginning of the incoming message tape, rewind the incoming message tape.

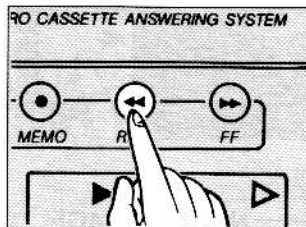

Press the REW button.

- The new messages will be recorded from the beginning of the incoming message tape.

Listening to the recorded messages —

When new incoming messages have been recorded, the call counter shows the number of recorded messages (0 to 99) and the ANSWER ON indicator flashes.

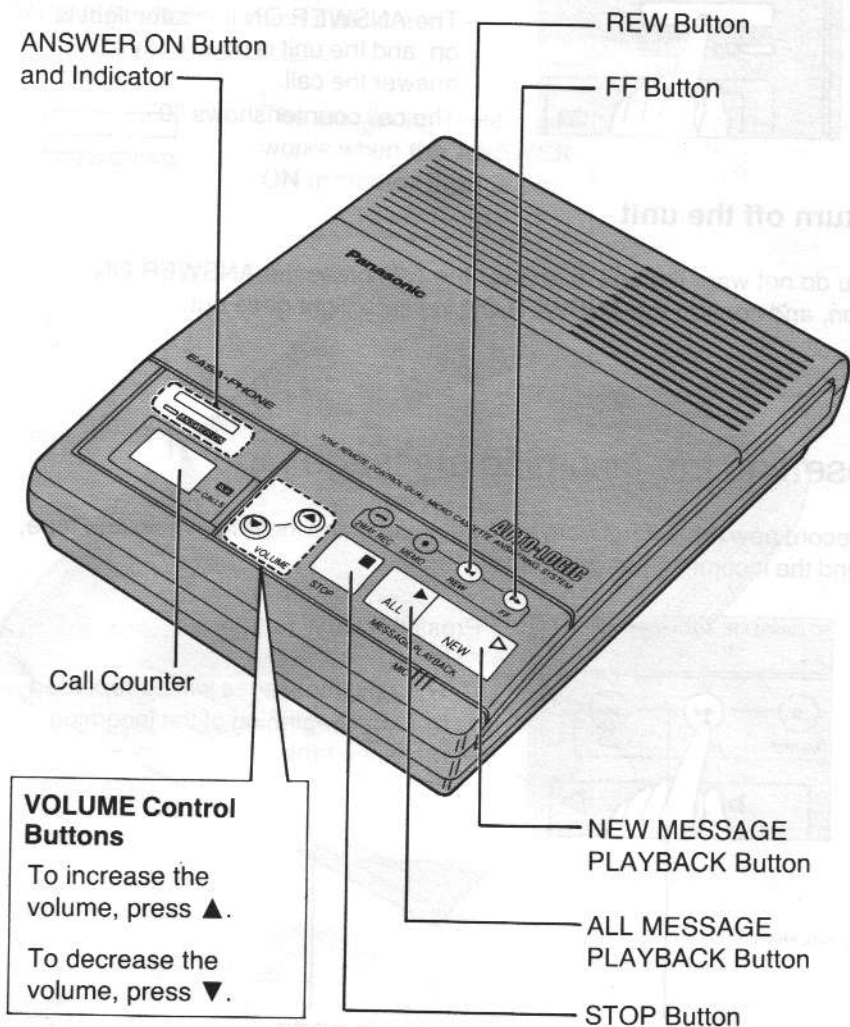

Note:

— When the MESSAGE ALERT selector is set to the "ON" position, the unit beeps every 10 seconds. (See page 9.)

Listening to new messages only

Only new messages are played back. (Messages once reviewed will not be played back.)

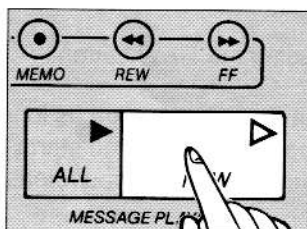

Press the NEW MESSAGE PLAYBACK button.

- The unit plays back new messages.
- At the end of the last message, 3 beeps sound and the tape stops automatically.

Listening to all the recorded messages

All the recorded messages (including those previously reviewed or saved) will be played back from the beginning of the tape.

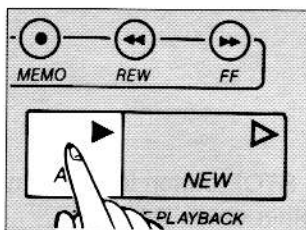

Press the ALL MESSAGE PLAYBACK button.

- The unit plays back all the recorded messages.
- At the end of the last message, 3 beeps sound and the tape stops automatically.

AUTO-LOGIC™

When you use the NEW MESSAGE PLAYBACK or ALL MESSAGE PLAYBACK button to listen to the recorded messages, the unit automatically;

- rewinds the tape and plays back the messages
- tells you the end of the last message by beeping 3 times
- prepares to record new messages after the old messages

We named this PLAYBACK buttons' feature "AUTO-LOGIC".

The following functions are available during message playback.

To rewind the tape during playback

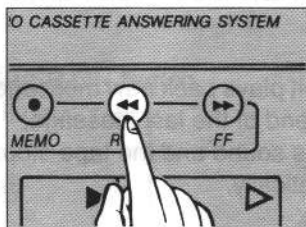

Keep pressing the REW button.

- The unit rewinds the tape as long as you press the button, and starts to play back again when you release it.

To fast forward the tape during playback

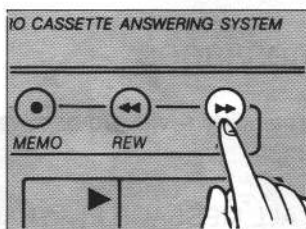

Keep pressing the FF button.

- The unit forwards the tape as long as you press the button, and starts to play back again when you release it.

To stop the operation

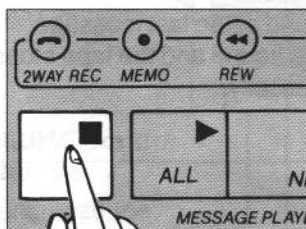

Press the STOP button to stop playing back, or other operation.

In case your unit is not in playback operation.

When you press the REW button, the unit rewinds the tape to the beginning automatically.

When you press the FF button, the unit forwards the tape to the end of the last message automatically.

Saving some old messages

If you do not want to clear away some old messages previously recorded, you can save them.

1

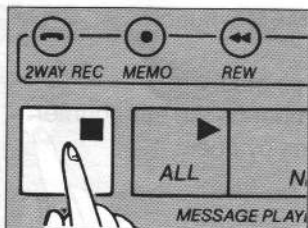

Play back the messages, then press the STOP button at the end of the message you want to save.

2

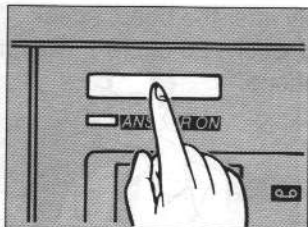

Press the ANSWER ON button to turn on the answering system.

- The ANSWER ON indicator light is on.
- The new messages will be recorded after the message(s) you have saved.

Note:

- Many states have introduced regulations on the manner in which telephone messages may be recorded. You should check with your telephone company to determine if you should record other than your own conversation being recorded. Contact your telephone company for further information.

Recording your own message

You may record a personal message on the ICM tape. It can be heard by anyone playing back messages remotely or manually.

1

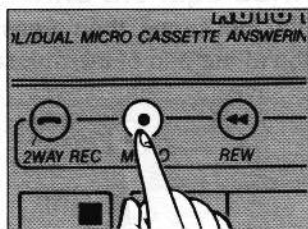

Press the MEMO button.

- A beep sounds.
- The number on the call counter increases by one.

2

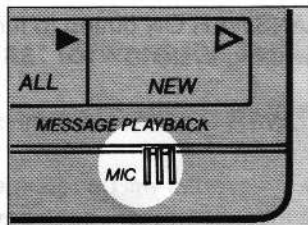

Immediately after the beep, speak clearly and loudly, 20 cm (8") away from the microphone.

3

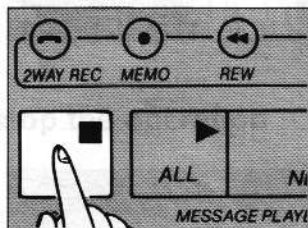

To stop recording, press the STOP button.

Recording a telephone conversation -

While speaking with someone on the telephone, you can record your conversation.

1

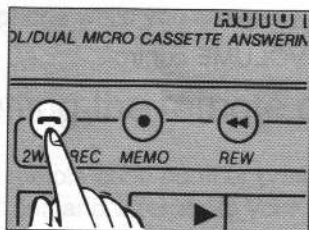

During your conversation, press the 2WAY REC button.

- A beep sounds.
- The number on the call counter increases by one.

2



Continue your conversation.

3

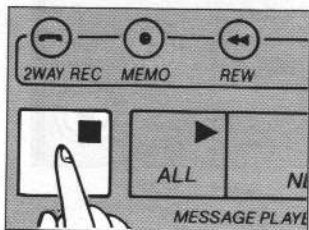

To stop recording, press the STOP button.

Note:

- Many states have imposed regulations on the manner in which 2-way telephone conversations may be recorded, so you should inform the other party that the conversation is being recorded. Consult your local telephone company for further information.

Monitoring incoming calls

While an incoming call is being recorded, you can monitor the caller's voice through the speaker and answer it if you want.

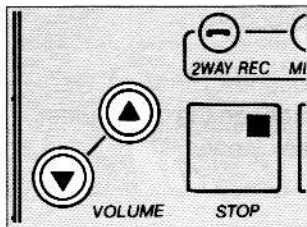

Adjust the VOLUME control.

Helpful hints:

- To answer the call while monitoring, lift up the telephone handset connected with the same line and talk. The unit stops recording.
- You can also answer the call while the unit is playing the greeting message in the same way.

If the unit does not stop playing the greeting message, press the hookswitch on the telephone for about one second, and release it.

Remote operation from a touch tone phone

You can operate your answering system remotely with a touch tone telephone while you are away from home.

Setting the remote code number

The remote code number prevents unauthorized persons from accessing your unit and listening to your messages. You can choose any 2-digit number (00 to 99) for your remote code number.

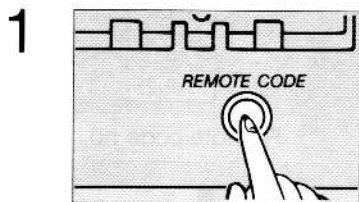

Press the REMOTE CODE button.

— The call counter shows the current remote code number.

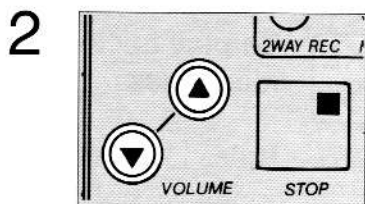

Within 5 seconds after pressing the REMOTE CODE button, press the VOLUME control buttons (▲ or ▼) repeatedly to select the number.

— Wait for 5 seconds after selecting the number.
Then the number on the call counter is stored, and it changes into the number of messages.

To check the remote code

Press the REMOTE CODE button.

The call counter shows the programmed remote code number for 5 seconds.

Basic remote operation

1

Call your unit from a touch tone telephone.



2

Press your remote code number during greeting message playback.

— A beep sounds to tell you the number of new messages up to 8 times.



Remote code no.

3

GHI
4

To play back new messages only

Press **4** button.

— The unit plays back only the messages that were recorded since the last time you retrieved.

JKL
5

To play back all messages

Press **5** button.

— The unit plays back all the recorded messages.

3 beeps sound at the end of playback.

4

Hang up. The messages are saved.

During playback

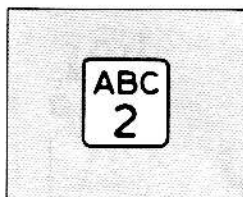

To skip the tape

Press  button.

- The unit skips the tape for a few seconds during playback and starts playback.

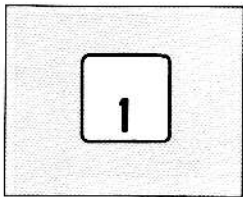

To back space the tape

Press  button.

- The unit rewinds the tape for a few seconds during playback and starts playback.

To reset the tape after playback

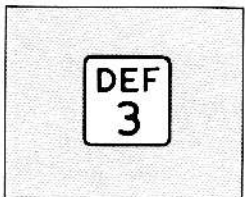

Press  button.

- When you played back all messages, the unit rewinds the tape to the beginning.
- When you played back only new messages, the unit rewinds the tape to the beginning of new messages.
- A beep sounds after rewinding tape.

If you want to rewind the tape to the beginning after played back only new messages:

Press  button again after hearing a beep (the tape has been reset).

- The unit rewinds the tape to the beginning.

If you want to cancel resetting of the tape:

Press  button after hearing a beep (the tape has been reset).

Advanced remote operation

1

Call your unit from a touch tone telephone.



2

Press your remote code number during greeting message playback.



— A beep sounds to tell you the number of new messages up to 8 times.

Remote code no.

3

To re-record the greeting message

① Press **7** button.

— The unit rewinds the greeting message tape to the beginning.

② Speak immediately after a long beep.

— Do not pause for over 5 seconds, or 6 beeps sound and the recording results in failure. Start again from step ① within 10 seconds after hearing 6 beeps.

③ To stop recording, press **9** button.

— The newly recorded greeting message will be played back.
— When you want to re-record, start again from step ①.

4

Hang up to end the remote operation.

To skip the greeting message (For outside caller)

Press button during greeting message playback.

- Callers can record their messages without listening to your greeting message.

To monitor the room sound

Press button.

- You can monitor the sound in the room where the unit is installed for 30 seconds.
- A beep sounds after 30 seconds.

If you want to monitor again after the time-out has come:

Press button again within 10 seconds of hearing the beep.

To turn off the answering system

Press button.

Your answering machine is automatically turned off. Then, hang up.

To turn on the answering system

You can easily turn on the answering system even when you forgot to turn it on.

1

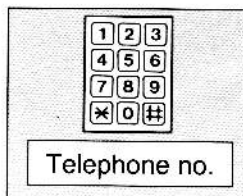

Call your unit from a touch tone telephone.

2

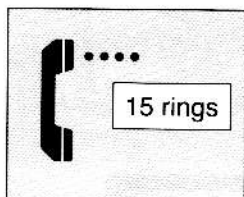

Wait for 15 rings.

— The unit will answer, and the greeting message is heard.

Then, hang up.

To record your own message

After playing back the recorded messages, you can leave your own message on the tape.

1. Wait for 10 seconds after hearing 3 beeps indicating the end of playback. Then 2 beeps sound.
2. Start to speak after hearing 2 beeps.
3. To finish recording, hang up.

OPERATION FROM TONE PHONE

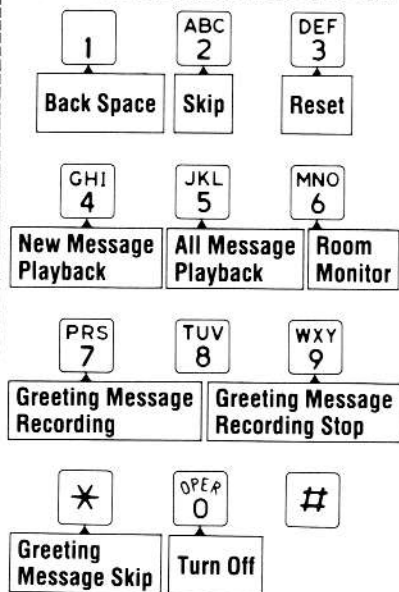

Call your unit.

Press remote code no. _____

- To playback all messages, press **5**.
- To playback new messages, press **4**.
- For back space, press **1**.
- For skip, press **2**.
- To reset the tape after playback, press **3**.
- To record your own message, speak after hearing 2 beeps at the end of playback.
- To save the messages, hang up after playback.

OPERATION FROM TONE PHONE

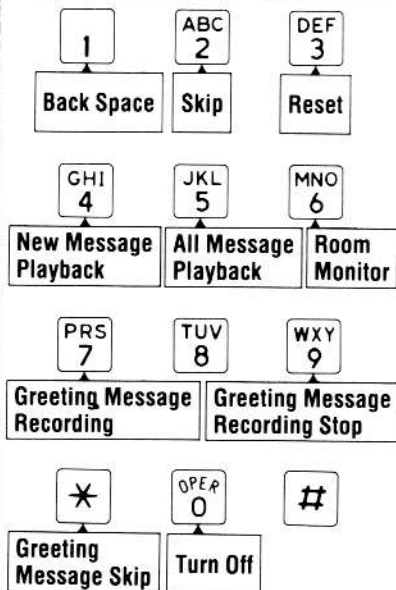

Call your unit.

Press remote code no. _____

- To playback all messages, press **5**.
- To playback new messages, press **4**.
- For back space, press **1**.
- For skip, press **2**.
- To reset the tape after playback, press **3**.
- To record your own message, speak after hearing 2 beeps at the end of playback.
- To save the messages, hang up after playback.

Call your unit.

To skip greeting message,
press ***#**.

Press remote code no. _____

To turn off the answering system,
press **0** then hang up.

To re-record greeting message,

1. Press **7**.
2. Speak after the long beep.
Do not pause for over
5 seconds.
3. When finished, press **9**.

To monitor room sound, press **6**.

—When you press a button,
press firmly.

—**To turn on the answering system,**
call your unit and wait for 15 rings.
The unit will answer, then hang up.

—**To check your remote code
number,** open the cassette panel,
then press the REMOTE CODE
button. Your remote code number is
shown on the call counter.

Call your unit.

To skip greeting message,
press ***#**.

Press remote code no. _____

To turn off the answering system,
press **0** then hang up.

To re-record greeting message,

1. Press **7**.
2. Speak after the long beep.
Do not pause for over
5 seconds.
3. When finished, press **9**.

To monitor room sound, press **6**.

—When you press a button,
press firmly.

—**To turn on the answering system,**
call your unit and wait for 15 rings.
The unit will answer, then hang up.

—**To check your remote code
number,** open the cassette panel,
then press the REMOTE CODE
button. Your remote code number is
shown on the call counter.

Troubleshooting guide

The unit does not work, and/or I cannot remove the tape from the unit.

- Plug in the AC adaptor again.

The answering system is on but no incoming messages are recorded.

- The greeting message is recorded improperly or not recorded, so no one can leave a message. Check and record a new greeting message.
- The incoming message tape is full. Reset it or replace with a new one.

The call counter shows “E”.

- The greeting message cassette tape might be broken. Replace it with a new one.

6 quick beeps sound during greeting message recording, and it results in failure.

- Re-record your greeting message. Speak clearly and loudly, and do not pause for over 5 seconds while recording.

When a message is played back, the sound level is low, even if the VOLUME is high.

- Clean the heads. (See page 32.)
- Replace the incoming message tape with a new one.

The unit does not answer remotely.

- The answering system is turned off. (The unit is not in the answer mode.) To set the unit to answer the call, call your unit and wait for 15 rings. (See page 28.)

I press the dial button of a touch tone phone after my unit answers, but the answering system does not respond.

- Make sure that you press your correct remote code number. To check your remote code number, see page 23.
- The answering system may not respond if a remote touch tone phone produces tones that are too short to activate the unit, so when you press any button, press firmly.

Some incoming messages have not been recorded up to end.

- Program the CPC function to the “b” position. (See page 13.)

While operating the unit, the AC adaptor feels warm.

- This is a normal condition.

Maintenance

Tape deck

Since the head and capstan assemblies are in contact with the tape, dirt and residue from the tape may easily adhere to these parts, causing distortion. These parts should be cleaned periodically in the manner described below.

Clean the head surface, pinch roller and capstan with a cotton swab. If these surfaces are extremely dirty, wipe them with the cotton swab dampened with alcohol, then wipe them with a dry soft cloth.

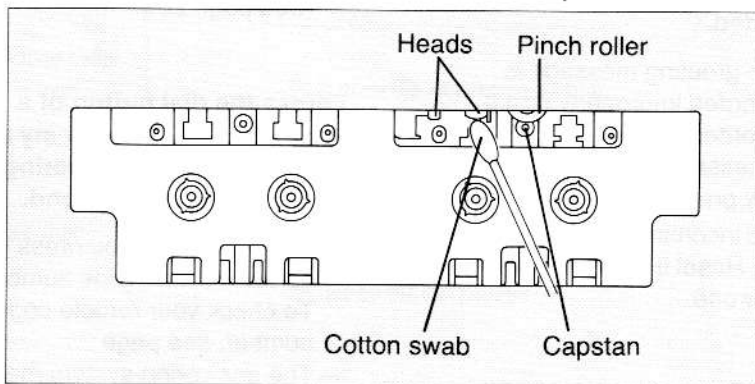

Note:

- Do not bring magnetic or metal objects, such as a screwdriver, near the head assemblies, as such objects could magnetize the heads.
- Do not oil any part of the unit.

Cassette tape

- For optimum sound quality and performance, we recommend that you **use the opposite side (side-2) after six months and replace the tape with a new one every year**, assuming that the unit answers about ten calls a day.
- Never place a cassette tape near a magnetic source, such as a magnet or a TV set; because it may erase or distort the recorded message on the tape.
- Slack in the tape can be tightened by rotating the tape reel with an instrument like a pencil, as shown.

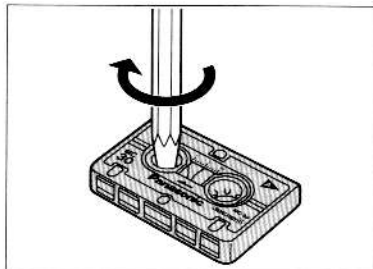

Cassette panel installation

If the panel comes off, replace it by pushing as shown.

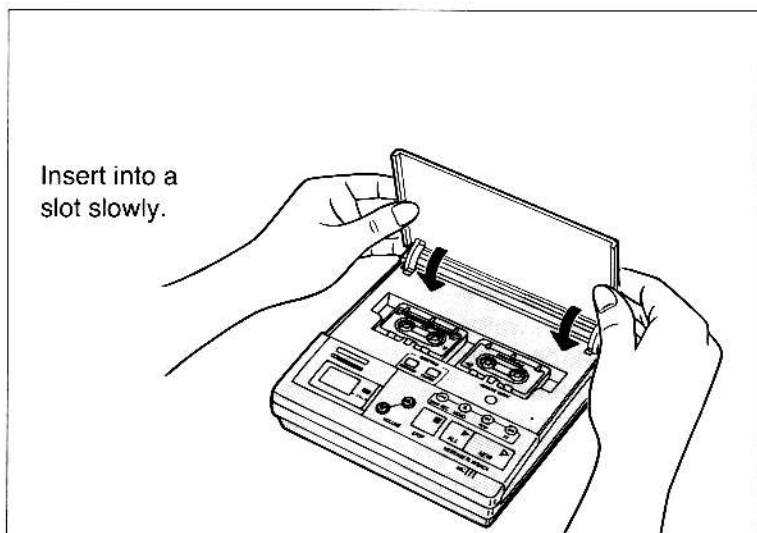

Accessory order information

Replacement parts and accessories are available through your local authorized parts distributor. For the authorized distributors in your area, call toll free: 1-800-332-5368

Part No.	Description
MC-30	Micro cassette tape for incoming message
MC-10	Micro cassette tape for greeting message

Important safety instructions ---

When using this unit, basic safety precautions as below should always be followed to reduce the risk of fire, electric shock, or personal injury.

1. Read and understand all instructions.
2. Follow all warnings and instructions marked on this unit.
3. Unplug this unit from wall outlets before cleaning. Do not use liquid or aerosol cleaners. Use a damp cloth for cleaning.
4. Do not use this unit near water, for example, near a bath tub, wash bowl, kitchen sink, or the like.
5. Install this unit securely on a stable surface. Serious damage may result if the unit falls.
6. Do not cover slots and openings of the unit, for they are provided for ventilation and protection against overheating. Never place the unit near radiators, in/or a place where proper ventilation is not provided.
7. Use only the power source as marked on the unit. If you are not sure of the type of the power supply to your home, consult your dealer or local power company.
8. Do not place objects on the power cord. Install the unit where no one can step on the cord.
9. Do not overload wall outlets and extension cords as this can result in the risk of fire or electric shock.
10. Never push any objects into this unit through slots as they may result in risk of fire or electric shock. Never spill any liquid on the unit.
11. To reduce the risk of electric shock, do not disassemble this unit, but take it to a qualified serviceman when some service or repair work is required. Opening or removing covers may expose you to dangerous voltages or other risks. Incorrect reassembly can cause electric shock when the appliance is subsequently used.
12. Unplug this unit from the wall outlet and refer servicing to qualified service personnel under the following conditions:
 - A. When the power supply cord or plug is damaged or frayed.
 - B. If liquid has been spilled into the unit.
 - C. If the unit has been exposed to rain or water.
 - D. If the unit does not work normally by following the operating instructions. Adjust only controls covered by the operating instructions, for improper adjustment may require extensive work by a qualified technician.

- E. If the unit has been dropped or damaged.
 - F. If the unit exhibits a distinct change in performance.
13. During thunderstorms, avoid using telephones except cordless types. There may be a remote risk of electric shock from lightning.
 14. Do not use this unit to report a gas leak in the vicinity of it.

SAVE THESE INSTRUCTIONS

INSTALLATION:

1. Never install telephone wiring during a lightning storm.
2. Never install telephone jacks in wet locations unless the jack is specifically designed for wet locations.
3. Never touch uninsulated telephone wires or terminals unless the telephone line has been disconnected at the network interface.
4. Use caution when installing or modifying telephone lines.

WARNING:

TO PREVENT FIRE OR SHOCK HAZARD, DO NOT EXPOSE THIS PRODUCT TO RAIN OR ANY TYPE OF MOISTURE.

FCC and other information ---

If requested by the telephone company, inform them as follows:
FCC registration No.

(found on the bottom of the unit)

Ringer Equivalence 0.2B

The particular telephone line to which the equipment is connected.

This unit must not be connected to a coin operated line.

If you are on a party line, check with your local telephone company.

Ringer Equivalence No.(REN):

The REN is useful in determining the quantity of devices you may connect to your telephone line and still have all of those devices ring when your telephone number is called.

In most, but not all areas, the sum of the REN's of all devices connected to one line should not exceed five (5.0). To be certain of the number of devices you may connect to your line, as determined by the REN, you should contact your local telephone company to determine the maximum REN for your calling area.

In the event terminal equipment causes harm to the telephone network, the telephone company should notify the customer, if possible, that service may be stopped.

However, where prior notice is impractical, the company may temporarily cease service providing that they:

- (a) Promptly notify the customer.
- (b) Give the customer an opportunity to correct the problem with their equipment.
- (c) Inform the customer of the right to bring a complaint to the Federal Communication Commission pursuant to procedures set out in FCC Rules and Regulations Subpart E of Part 68.

The Telephone Company may make changes in its communications facilities, equipment, operations or procedures, where such action is reasonably required in the operation of its business and is not inconsistent with the rules and regulations in FCC Part 68.

If such changes can be reasonably expected to render any customer terminal equipment incompatible with telephone company communications facilities, or require modification or alteration of such terminal equipment, or otherwise materially affect its use or performance, the customer shall be given adequate notice in writing, to allow the customer an opportunity to maintain uninterrupted service.

CAUTION:

To assure continued compliance with FCC rules, do not make any unauthorized modifications.

Note:

This equipment has been tested and found to comply with the limits for a Class B digital device, pursuant to Part 15 of the FCC Rules. These limits are designed to provide reasonable protection against harmful interference in a residential installation. This equipment generates, uses, and can radiate radio frequency energy and, if not installed and used in accordance with the instructions, may cause harmful interference to radio communications. However, there is no guarantee that interference will not occur in a particular installation. If this equipment does cause harmful interference to radio or television reception, which can be determined by turning the equipment off and on, the user is encouraged to try to correct the interference by one or more of the following measures:

- Reorient or relocate the receiving antenna.
- Increase the separation between the equipment and receiver.
- Connect the equipment into an outlet on a circuit different from that to which the receiver is connected.
- Consult the dealer or an experienced radio/TV technician for help.

- If there is any trouble, disconnect the unit from the telephone line and connect a known working phone. If the known working phone operates properly, have your unit repaired by one of the specified Panasonic Factory Service Centers. If the known working phone does not operate properly, consult with your telephone company.
- The unit should not be placed in room where the temperature is less than 5°C (41°F) or greater than 40°C (104°F).
- The unit should be situated so that the location or position does not interfere with its proper ventilation. Allow 10 cm (4") clearance around the unit.
- When the unit is not used, turn the power off. When left unused for long periods of time, the unit should be unplugged from the household AC outlet.
- Do not place heavy objects on top of this unit.
- Place the unit on a flat level surface. Damp basements should also be avoided.
- Do not subject this unit to excessive smoke, dust, mechanical vibration, shock, or direct sunlight.

Referencia rápida

Inserción de microcasetes

Extraiga el tope.

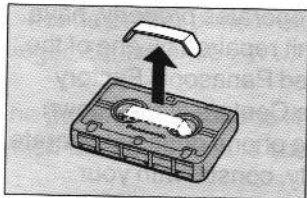

Abra el panel.

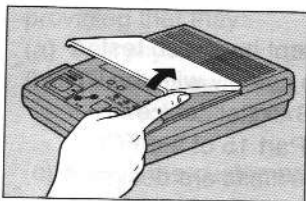

Inserte los microcasetes con sus carretes con la cinta bobinada hacia el lado izquierdo.

Cinta de mensajes de saludo
(MC-10)



Etiqueta azul

Cinta de mensajes entrantes
(MC-30)

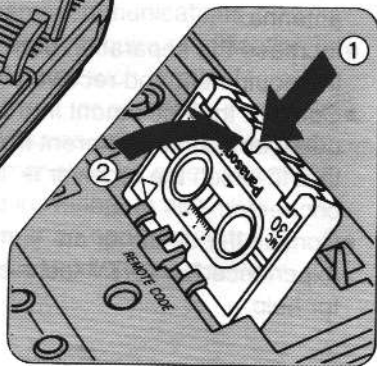
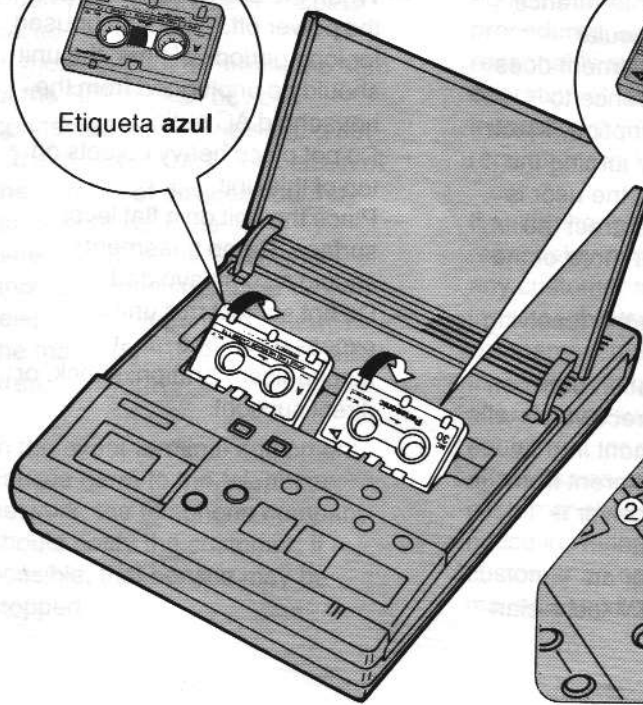

Conexión

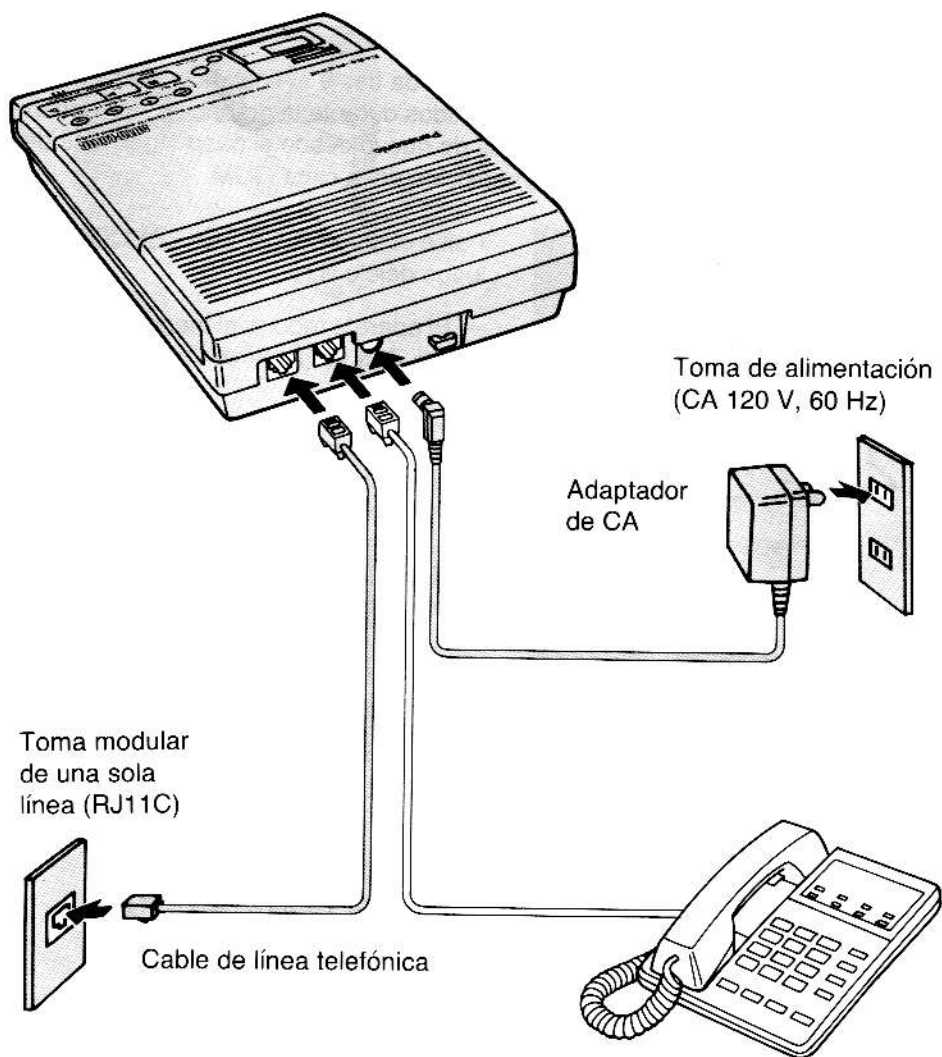

Nota:

— Utilice solamente el adaptador de CA Panasonic KX-A11.

Grabación de un mensaje de saludo

El mensaje de saludo sirve para avisar a la persona que llama que usted no puede contestar a la llamada y pedirle que deje un mensaje grabado.

Precaución:

- Usted podrá grabar su mensaje de salida hasta el final de la cinta.
- No haga pausas de más de 5 segundos durante la grabación. Si suenan 6 pitidos mientras graba, empiece de nuevo desde el paso 1 después de que el aparato ponga fin a la reposición de la cinta OGM.

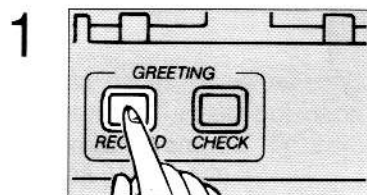

Pulse el botón GREETING RECORD y luego déjelo libre.

- El aparato repone el mensaje de saludo y luego emite un pitido largo.

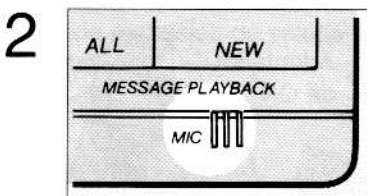

Inmediatamente después de escuchar un pitido largo, hable de forma clara y alta a unos 20 cm (8") del micrófono.

- El contador de llamada va añadiendo el tiempo de su grabación.

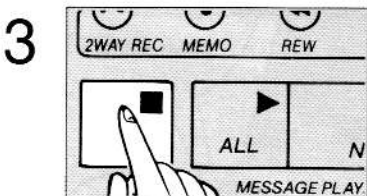

Pulse el botón STOP cuando finalice la grabación.

Preparación del aparato para contestar una llamada

Para contestar una llamada y grabar los mensajes de las personas que llaman, prepare el aparato de la forma siguiente:

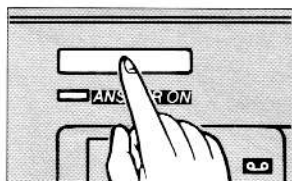

Pulse el botón ANSWER ON para encender el sistema de contestación.

- El indicador ANSWER ON se enciende.

Escucha de mensajes nuevos solamente

Sólo se reproducen los mensajes nuevos. (Los mensajes que ya han sido revisados una vez no se reproducirán.)

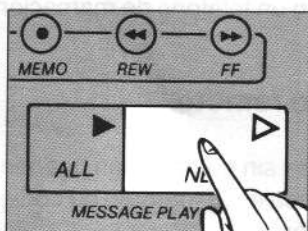

Pulse el botón **NEW MESSAGE PLAYBACK**.

Escucha de todos los mensajes grabados

Todos los mensajes grabados (incluyendo aquellos que previamente han sido revisados o almacenados) se reproducirán desde el principio de la cinta.

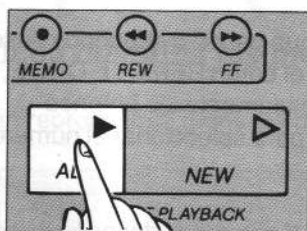

Pulse el botón **ALL MESSAGE PLAYBACK**.

Control a distancia desde un teléfono de marcación por tonos

Mientras usted se encuentra ausente de su hogar, el sistema de contestación puede controlarse a distancia con un teléfono de marcación por tonos.

Para establecer el número de código remoto

El número de código remoto evita que personas sin autorización puedan tener acceso a su aparato y escuchar sus mensajes. El número de código remoto está formado por un número de 2 dígitos.

1

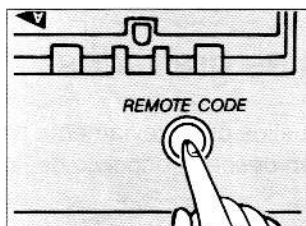

Pulse el botón REMOTE CODE.

— El contador de llamada muestra el número código remoto actual.

2

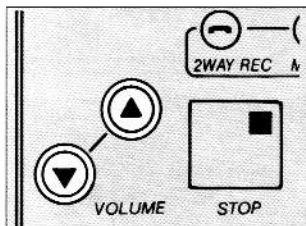

Antes de que pasen 5 segundos desde que pulsa el botón REMOTE CODE, pulse repetidamente los botones VOLUME para seleccionar el número (00 a 99).

— Espere 5 segundos después de haber seleccionado el número. Luego, el número se almacena en la memoria y el número del contador de llamadas cambia al número de mensajes.

Para comprobar el código remoto

Pulse el botón REMOTE CODE.

El visualizador muestra el número del código remoto programado durante 5 segundos.

Escucha de mensajes nuevos solamente

Usted podrá escuchar los mensajes nuevos solamente, sin necesidad de reproducir los mensajes que ya haya escuchado previamente.

1

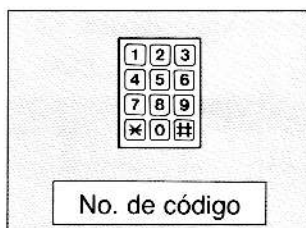

Llame a su aparato y pulse el número de código remoto durante la reproducción del mensaje de saludo.

2

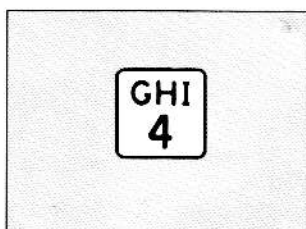

Pulse "4" antes de que pasen 3 segundos desde que escucha pitidos cortos.

Escucha de todos los mensajes grabados

Podrán reproducirse todos los mensajes.

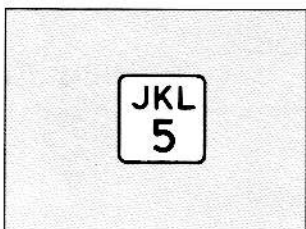

Pulse "5" antes de que pasen 3 segundos desde que escucha pitidos cortos que indican el número de mensajes nuevos.

Notas:

- Cuando llame a su aparato y pulse el número de código remoto, el aparato espera 5 segundos el comando de operación. Si no hay comando de operación, el aparato inicia la reproducción de todos los mensajes grabados.
- Durante la reproducción de todos los mensajes grabados, pulsando "4" usted podrá omitir este tipo de reproducción y escuchar los nuevos mensajes grabados.